



萬達光電科技股份有限公司

HIGGSTEC INC.

PRODUCT SPECIFICATIONS

產品規範書

Customer (客戶): _____

Model (型式): T121S-5RB014N-0A18R0-200FH

Mode (種類): Five-wire Analog Resistive

Date (日期): Jul. 09, 2012

Version (版本): 6.08.01

Customer Approval

客戶簽認

HIGGSTEC INCORPORATED

8 F., No. 609, Wan Shou Rd., Sec. 1,
Kweishan, Taoyuan Hsien 33350,
Taiwan.

TEL : 886-2-8209-9696

FAX : 886-2-8200-3030

E-mail : info@higgstec.com.tw

Approve 確認	Review 審訂	Preparation 製表
		

TABLE OF CONTENTS

目 錄

00. Specification Revision Record [規格變更記錄].....	01
00. Dimension Drawing [尺寸圖].....	02
01. Scope [範圍].....	03
02. Features [特性].....	03
03. General Specification [一般規格].....	03
04. Environmental Characteristics [環境特性].....	03
05. Optical Characteristics [光學特性].....	04
06. Electrical Characteristics [電子特性].....	04
07. Mechanical Characteristics [機械特性].....	05
08. Reliability [可靠度].....	05
09. Durability [耐久性].....	05
10. Inspection Methods [檢查方法].....	06
11. Appearance Inspection [外觀檢查].....	07
12. Attention for Mounting Condition [裝機注意事項].....	08
13. Warranty [保固].....	09
14. Appendices [附註].....	09
Appearance Specification [外觀檢查規格].....	12
15. Caution [注意事項].....	11/ 10

TOUCHSCREEN TABULATION	
PART NUMBER	TYPE
5RB014G	CLEAR
5RB014N	ANTI-GLARE

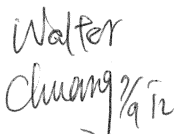
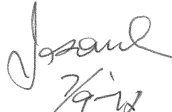
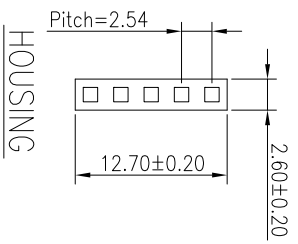

CONNECTOR PINOUT	
PIN NO.	DESIGNATION
1	RT
2	RL
3	SG
4	LT
5	LL

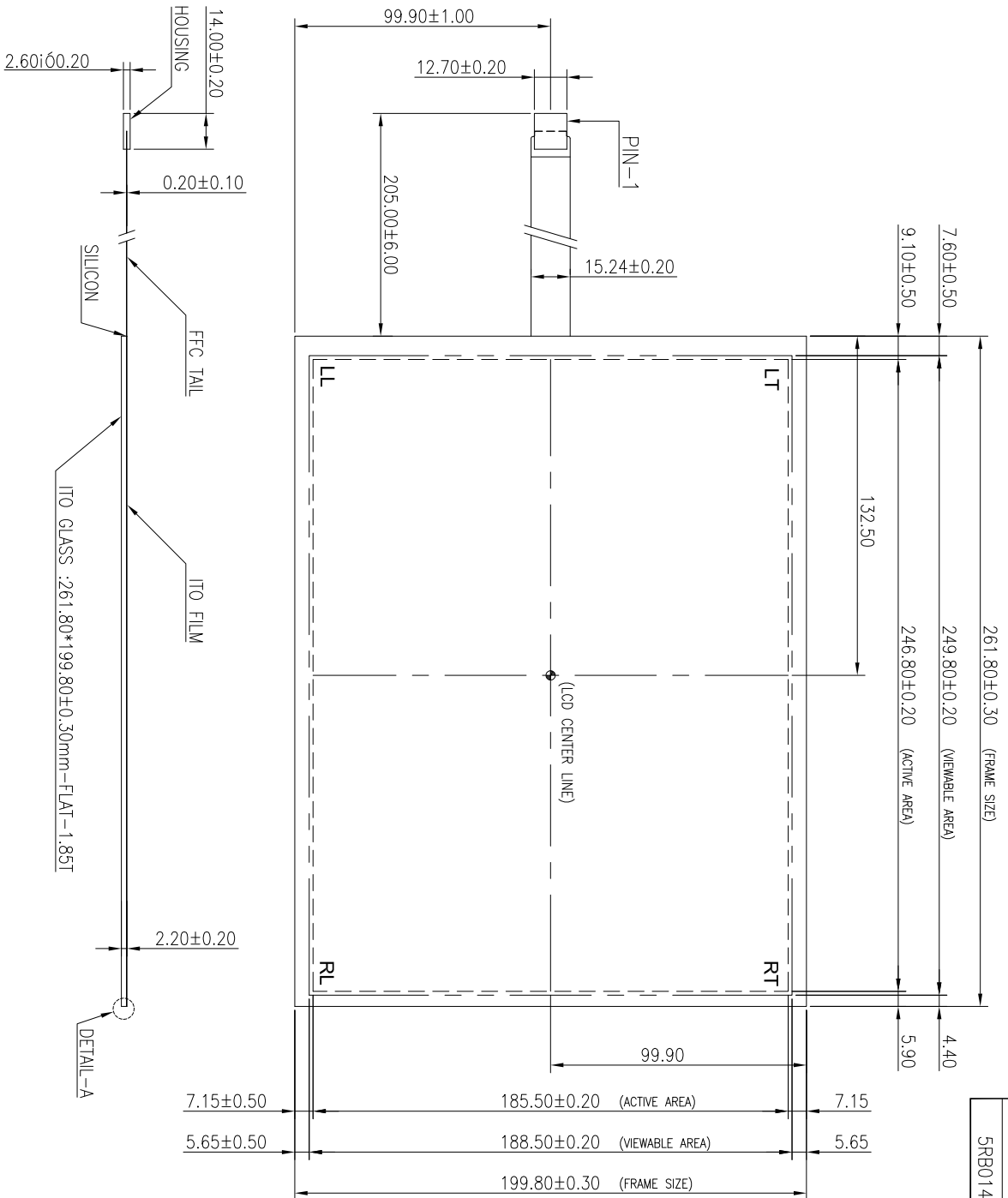
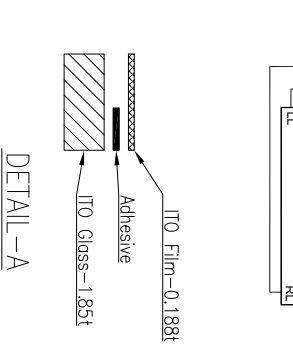
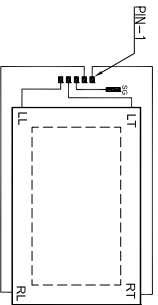

HIGGSTEC INC.

DESCRIPTION	WD-TR5-0033	DATE	DEC.24,2007	APPROVED		Rev.	A
MODEL	T121S-5RB014X-0A18R0-200FH	SCALE	-/-	DESIGN	<i>Shady</i>	Page	of
PART NO.		UNIT	mm.	DRAWING	<i>Barnd</i>	B-Page	of

01. Scope

[範圍]

The specification is for Five-Wire Analog Resistive touch panel.

[此規格適用於五線-類比電阻式觸控屏幕]

02. Features

[特性]

Item [項目]		Specifications [規格]
(1)	Type [型式]	Five-Wire Analog Resistive [五線-類比電阻式]
(2)	Input Mode [操作模式]	Stylus or Finger [筆觸或手觸]
(3)	Cable [連結線]	FFC

03. General Specification

[一般規格]

Item [項目]		Specifications [規格]
(1)	Frame Size [外框尺寸]	261.80±0.30 X 199.80±0.30 mm
(2)	View Area [可視區]	249.80±0.20 X 188.50±0.20 mm
(3)	Active Area [動作區]	246.80±0.20 X 185.50±0.20 mm
(4)	Total Thickness [總厚度]	2.20±0.20 mm
(5)	Tail Length [出線長度]	205.00±6.00 mm

04. Environmental Characteristics

[環境特性]

Item [項目]		Specifications [規格]	
		Temperature [溫度]	Humidity [濕度] (Non Condensing) [未凝結]
(1)	Operation [操作]	-10°C ~ +70°C	20%RH ~ 80%RH
(2)	Storage [儲存]	-40°C ~ +80°C	20%RH ~ 90%RH

Note: All terms under 1 atmosphere.
[註:於正常的 1 大氣壓下]

05. Optical Characteristics

[光學特性]

Item [項目]		Specifications [規格]
(1)	Transparency [透光度]	80% ± 3% (Measured by BYK-Gardner)
(2)	Haze [霧化度]	8% ± 3% (Measured by BYK-Gardner)

06. Electrical Characteristics

[電子特性]

Item [項目]		Specifications [規格]
(1)	Loop Resistance [迴路阻抗]	X:20~500Ω, Y:20~500Ω (See Figure 6-1)
(2)	Linearity [線性]	$X \leq 1.5\%$, $Y \leq 1.5\%$ (See Figure 10-2)
(3)	Chattering [作動時間]	$\leq 15\text{ms}$
(4)	Insulation [絕緣阻抗]	$\geq 20\text{M}\Omega/25\text{V}(\text{DC})$
(5)	Endurance [耐電壓]	No acting damage at DC50V/60sec.

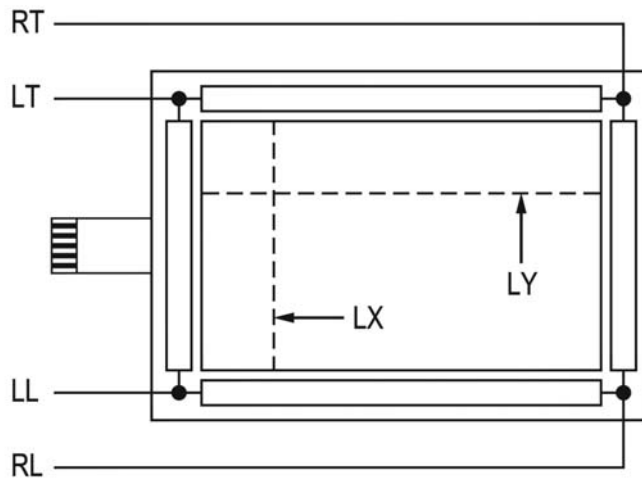

Figure 6-1

Loop Resistance X = short RT and RL , short LT and LL , measure the resistance between RT and LT
 Loop Resistance Y = short RT and LT , short RL and LL ,measure the resistance between RT and RL

07. Mechanical Characteristics

[機械特性]

Item [項目]	Specification [規格]	Condition [條件]
Operating Force [作動力]	Stylus= R0.8 [筆式=R0.8]	≤ 50g
Impact [撞擊]	25.0 φ DIA. Steel Ball/67g Height=50cm [25 φ /67g 鋼球 高度=50cm]	1 time, no damage [Impact at center area] [中央區域撞擊 1 次,不能破損]
Static Load [靜態承重]	5000g within 10cm ² area for 30sec [5000g 置於 10cm ² 內, 30 秒]	Satisfy(1) of Item 7 and (1), (2),(4) of Item 6 [符合 7 項目(1)及 6 項目(1),(2),(4)]
Hardness [硬度]	3H pencil, pressure 750g/45° [鉛筆 3H, 壓力 750g/45° (ASTM D3363)]	≥ 3H
Tail Peeling [Tail 剝離]	800g by vertical 90° [800g, 垂直 90°]	Satisfy (1) of Item 6 [符合 6 項目(1)]
Tail Bending [Tail 繞折]	90° 10 times up & down [90° 角, 上下來回 10 次]	Satisfy (1) of Item 6 [符合 6 項目(1)]

08. Reliability

[可靠度]

Item [項目]	Specification [規格]	Condition [條件]
High Temperature /Humidity [高溫高濕]	70°C /90%RH, 240 hrs, allow panel stays in normal environment for 4 hrs [70°C /90%RH, 240 小時, 回常溫 4 小時後始可測試]	Reliability test may cause the film puffed yet the electric characteristic; (1), (4) of Item 6; (2) of item 6 satisfies X ≤ 2.5%, Y ≤ 2.5%; Actuation force must not exceed 200g after reliability test. [經由可靠度測試後, 外觀不在其規範內, 但功能性仍符合以下條件 6 項目(1)、(4); 6 項目(2)符合 X ≤ 2.5%, Y ≤ 2.5%; 測試後作動力不能超過 200g]
High temperature [高溫]	70°C /240 hrs allow panel stays in normal environment for 4 hrs [70°C /240 小時, 回常溫 4 小時後始可測試]	
Low temperature [低溫]	-40°C /240 hrs allow panel stays in normal environment for 4 hrs [-40°C /240 小時, 回常溫 4 小時後始可測試]	
Thermal Cycle [冷熱循環]	-40°C ~70°C [60 min./cycle] *50 cycles allow panel stays in normal environment for 4 hrs [-40°C ~70°C, 每循環 60 分鐘, 共 50 次循環, 回常溫 4 小時後始可測試]	

09. Durability

[耐久性]

Item [項目]	Specification [規格]	Condition [條件]
Knock Test [觸擊測試]	10,000,000 times [1000 萬次]	(1), (4) of Item 6; (2) of item 6 satisfies X ≤ 2.5%, Y ≤ 2.5%; Actuation force must not exceed 200g after durability test. [6 項目(1)、(4); 6 項目(2)符合 X ≤ 2.5%, Y ≤ 2.5%; 測試後作動力不能超過 200g]

10. Inspection Methods :

[檢查方法]

(1) Linearity Condition [線性測試條件]

Step 1: short RT and RL(or short RL and LL).

Step 2: apply voltage DC 5V.

Step 3: short LT and LL (or short RT and LT).

Step 4: apply grounding.

Step 5: draw points along LX and LY at 5.0mm intervals within pattern area and detect the voltage at SG.

Step 6: measure the voltage differences between RT and LT (or RT and RL) (Fig 10-1) (Fig 10-2)

[將 RT, RL 短路(或 RL, LL 短路)並接上 5V 的直流電, 另外將 LT, LL 短路(或 RT, LT 短路)並接上接地線 0V, 以 5.0mm 的間隔, 利用手寫筆(stylus)劃直線(如圖 2 中 LX 和 LY), 並量測 SG 的電壓, 量測並計算 RT 與 LT 間的電位差(或 RT 與 RL 間的電位差)] (Fig 10-1) (Fig 10-2)

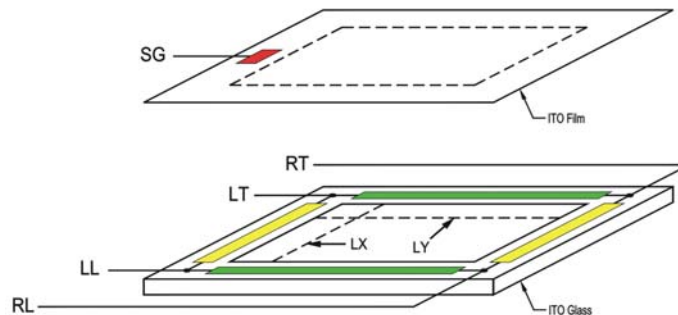

Figure 10-1

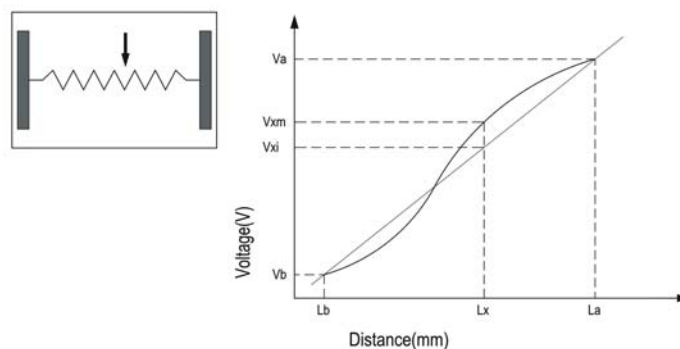

Figure 10-2

$$\ast \text{ Linearity: } [| V_{xm} - V_{xi} |] / (V_a - V_b) \times 100\%$$

(2) Specification [規範]

Linearity must meet the electrical characteristic specified in Item 6

[線性必須符合 6 項目的電性規範]

11. Appearance Inspection

[外觀檢查]

(1) 18W(1000±500Lux) fluorescent luminant lamp is used for appearance inspection. Detail settings are shown in (Fig 11-1) and (Fig 11-2).

[(1) 檢測始用之燈光為 18W(1000±500Lux)白熾燈光，詳細的擺設方式，請參考圖(Fig11-1), (Fig11-2)]

(2) Minor impurities outside active area are acceptable unless their existence affect electrical functions.

[(2) 只要不影響電器功能性，作動區外之外觀瑕疵是可以被允許的]

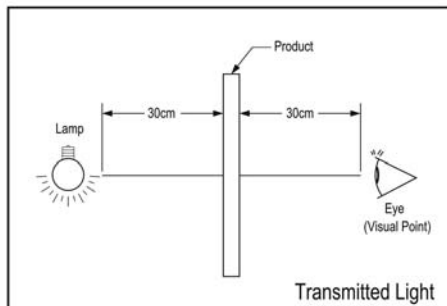

Figure 11-1

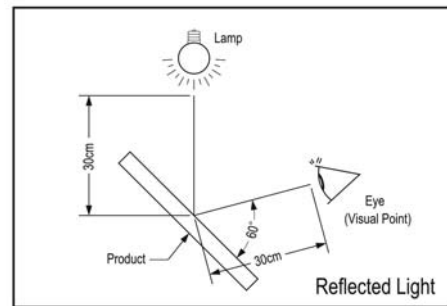

Figure 11-2

(3) Glass Flaw [玻璃瑕疵]

Item [項目]	Picture [圖示]	Specification [規格]
Corner Flaw [角瑕疵]		$X \leq 3.0\text{mm}$ $Y \leq 3.0\text{mm}$ $Z \leq T$
Edge Flaw [邊緣瑕疵]		$X \leq 3.0\text{mm}$ $Y \leq 3.0\text{mm}$ $Z \leq T$
Progressive Flaw [裂縫瑕疵]		Not allowed [不允許]

Note: T=Glass thickness

(4) Please refer to Appendix I : Appearance Specification.

[(4) 外觀規格請詳見(附註 1)]

12. Attention of Mounting Condition

[裝機注意事項]

- (1) The gasket support of touch panel must allocate outside of Viewable Area. Reserve enough clearance between panel surface and enclosure for normal panel operation.

To avoid pressing error, please retain enough space between surface panel and Bezel.

[請將固定觸控屏用的支撐體(support)設計於可視區(Viewable area)之外。為避免不小心碰到觸控屏而產生動作，請預留空間於面板與機體外殼之間]

- (2) Bezel opening must not touch Viewable Area, Bezel opening must be designed between Viewable Area and Active Area.

[外殼內緣(Bezel opening)應設計於可視區及動作區之間，並且不得碰到可視區]

- (3) We recommend elastic material support.

[建議使用彈性物質製成的支撐體]

- (4) Due to the conductive characteristic of the panel backside, prevent metal contact after mounting.

[觸控屏面板背面具導電性質，安裝後請避免與其他金屬物質接觸]

- (5) Do not use adhesive to bond top surface (ITO Film) of touch panel with enclosure.

[請勿使用黏著劑或雙面膠帶固定觸控屏面板和機體外殼]

- (6) Proper grounding of controller at all times assure normal operation.

[觸控屏正常的作動有賴於控制器確實的電源接地]

- (7) During assembly. Please take into consideration the variance in the different module designs, whether it would cause physical, cosmetic or functional damages to the touch panel, when completing the assembly.

[客戶端設計與觸控屏組裝時，不論客戶端的模組設計為卡桿式、螺母鎖固式或其他組裝方式時，請客戶端先行評估其模組的變異量，是否會影響組裝時造成觸控屏破損變形或其他外觀及功能性問題]

- (8) After installation, please perform 4 point and 25-point calibration.

[裝設完成需利用定位工具進行4點及25點校正]

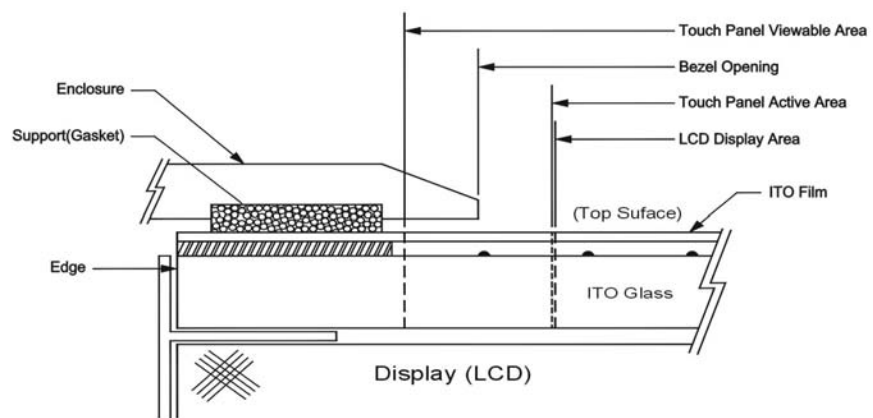

Figure 12-1

13. Warranty

[保固]

HIGGSTEC comes with a 2-year guaranty on all HIGGSTEC products. HIGGSTEC guaranty provide for repair and replacement without any charge during this period.

HIGGSTEC reserves the right in its sole discretion to determine the defects received, and will take the responsibility if there is any defect or damages.

[除了下列 4 點所述外，萬達光電所生產製造的產品保固期限為 2 年，若判定為萬達光電之責任，則產品更換。萬達光電保留判定責任歸屬之權益]

Limited warranty does not cover the following situations:

[有限度保固，不包括下列幾點]

Notice: HIGGSTEC is not responsible for following situation:

1. Damages caused by improper handling from clients, including shipping, installation and integration.

[在客戶的製程或運輸中,因客戶自身疏忽所造成對產品的傷害及破損]

2. Damages caused by either natural or human factors after receiving the products.

[在客戶收到萬達光電之產品後,因為天災人禍所造成的傷害及破損]

3. Damage caused by self-repairs, modifications or disassembling of the product.

[沒有知會萬達光電共同討論，而自行變更、維修、拆卸產品所造成的傷害及破損]

4. Damage caused by user error ; failing to follow normal operation procedures or using paper tools.

[客戶端於觸控屏使用操作上,該使用正確的動作及工具操作觸控屏,因客戶與依正確操作使用造成產品傷害及破損]

14. Appendix

[附註]

Item [項目]	Content [內容]	Page number [頁數]
Appendix I [附註一]	Appearance Specification [外觀檢查規格]	1 page

15. Caution

[注意事項]

Storage [儲存]	<p>Store panel under the temperature and humidity range pre-specified. Direct sunlight exposure or piling should be avoided. [儲存要注意溫/濕度條件，且不可直接暴露於陽光下，或堆疊造成直接加壓面板]</p> <p>Ship Method (1) must use legal couriers to transport products. (2) fragile products ; beware of vibration and dropping during transit. [搬運方法 (1) 需顧用合法搬運公司進行貨物離置 (2) 產品為易碎品, 搬運時需注意震動、掉落]</p> <p>Stacking method (1) based on standard air/ocean freight regulation (2) pallet use recommended for stacking (3) monitor stack weight and height to prevent damage to bottom stack [堆疊方法 (1) 依空運或海運堆放標準 (2) 建議利用棧板進行堆疊作業 (3) 注意堆疊重量及高度, 不可造成最下層包裝箱發生變形或破損]</p>
Unpack [拆裝]	<p>Unpack the box with the printed red arrow pointing up. [注意檢查包裝箱已發現來貨外箱已有嚴重變形或破損時, 應立即拍照佐證, 以避免損壞]</p>
Handing [握持]	<p>(1) Use clean sacks or glove to prevent fingerprints and/or stains left on the panel. Extra attention and carefulness should be taken while handling the glass edge. [配戴清潔的指套、手套、口罩, 以避免造成指紋、髒污或不小心被玻璃邊緣割傷]</p> <p>(2) Avoid touching the viewing area before installation/integration. [安裝組合時, 避免接觸可視區]</p> <p>(3) Holding the panel instead of the tail at all time. [拿取面板時, 不可直接拿取 tail 部份]</p>
Cleaning [清潔]	<p>(1) Use neutral detergent or isopropyl alcohol on a clean soft cloth to clean the panel surface. [使用乾淨且柔軟的布, 沾中性清潔劑或酒精進行清潔]</p> <p>(2) Prevent using any kind of chemical solvent, acidic or alkali solution. [不能使用化學溶劑或酸鹼液進行清潔]</p> <p>(3) Foreign objects and prints that can be wiped off are not regulated under the specification , can be ignored. [表面可擦拭及排除的異物及異紋並不列入判定規範內, 可被乎略]</p>

<p>Installing and Assembling [組合與裝配]</p>	<p>(1) Excessive force or strain to the panel or tail is prohibited. [注意避免加壓或拉扯面板及 tail]</p> <p>(2) Gasket or cushion pads around the edge of the panel may segregate water and/or dust contamination. [在設計機構時，注意四周邊緣需有緩衝墊，以避免滲水或聚集灰塵]</p> <p>(3) Maintain a minimal 5R when bending tail to prevent dead fold or fold mark. [組裝時應保持最小 5R 的折彎尺寸，並避免死折或有折痕現象]</p> <p>(4) Flaws in customer module design may cause functionality issues after assembly. [客戶端設計模組若有疏失時，會造成觸控屏組裝後，產生變形或破損現象會影響正常觸控功能]</p>
<p>Operating [操作]</p>	<p>(1) Touch the panel with your finger or stylus only to assure normal operation. Any sharp edged or hard objects are prohibited. [應用手指或專用觸控工具，不能使用尖銳、堅硬的物體書寫輸入]</p> <p>(2) Operate the panel in a steady environment. Abrupt variation on temperature and humidity may cause malfunction of the panel. [急遽的溫/濕度變化會有結露現象，易造成面板功能失效，所以穩定的環境條件是必要的]</p> <p>(3) Avoid applying excessive activation force or sudden impact on the panel surface. [避免應用過大觸動力或瞬間衝擊面板表面]</p>
<p>Others [其他]</p>	<p>(1) Keep the panel surface clean. Prevent any kind of adhesive applied on the surface. [請保持表面清潔，不要貼膠帶於面板上]</p> <p>(2) Avoid high voltage and/or static charge. [避免高壓與靜電]</p> <p>(3) HIGGSTEC has the right to change the materials and/or specifications. [萬達光電保有變更規格及材料的權利]</p>



Appearance Specification

【Appendix I】

Item [項目]	Specification [規格] Unit: mm
Particle [顆粒異物]	(1) $D \leq 0.25 \rightarrow \text{OK}$ (2) $0.25 < D \leq 0.4$ (each area contains ≤ 3 , total ≤ 5) $\rightarrow \text{OK}$ (3) $D > 0.4 \rightarrow \text{NG}$
Linear Object [線狀異物]	(1) $W \leq 0.05 \rightarrow \text{OK}$ (2) $0.05 < W \leq 0.1$ and $L \leq 5.0$, total $\leq 3 \rightarrow \text{OK}$ (3) $W > 0.1 \rightarrow \text{NG}$ Remark: the particle will be ignored when it is cleanable.
Scratch [刮傷]	(1) $W \leq 0.025 \rightarrow \text{OK}$ (2) $0.025 < W \leq 0.05$ and $L \leq 12.0$, total $\leq 5 \rightarrow \text{OK}$ (3) $0.05 < W \leq 0.1$ and $L \leq 6$, total $\leq 5 \rightarrow \text{OK}$ (4) $W > 0.1 \rightarrow \text{NG}$

<Endorse> 【備註欄】

1. All appearance flaws outside AA are acceptable. 【except glass flaws , corner flaws , edge flaws , progressive flaws and scratches mast follow appearance inspection】。

[所有外觀不良，只要超出 AA 區，均忽略不計【除玻璃破損、缺角、邊緣瑕疵、裂縫、刀傷問題，依成品外觀檢驗規範進行檢驗】。]

2. D=Diameter=直徑。

3. W=Width=寬度。

4. L=Length=長度。

